

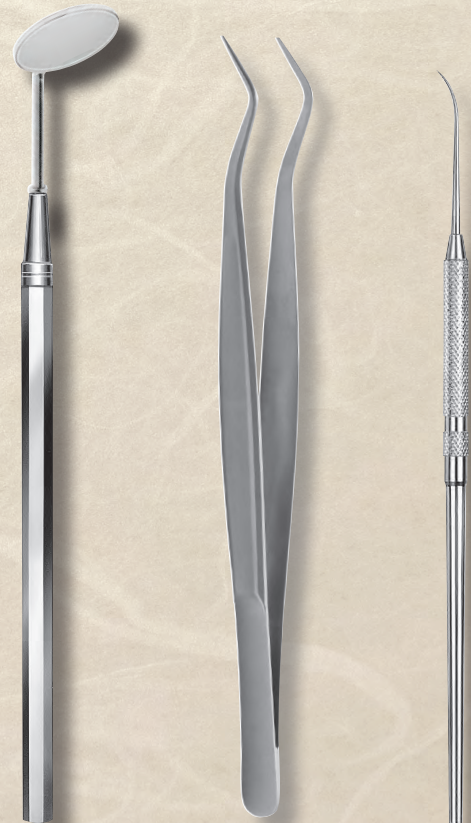

# Diagnosis

Explorer	2
Excavator	5
Dressing Tweezers	6
Mouth Mirror	8
Disposable Instrument	10
Temporary Filling Instrument	10
Evacuation Tip	11
Stainless Dish / Tray	12





## Explorer

### -Single End-



**#3**  
No. 01003



**#5**  
No. 01005



**#9**  
No. 01009



**#23**  
No. 01023



**#25**  
No. 01025

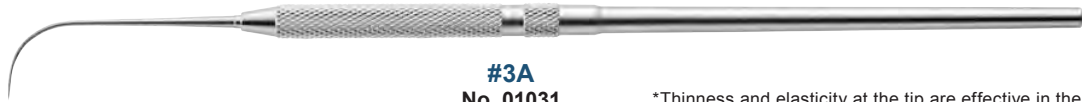

**#3A**  
No. 01031

\*Thinness and elasticity at the tip are effective in the check of dental tartar, cavity and surplus cement.



**Multi**  
No. 01030

\*A tip part is made thick for intensity.



**#23BS**  
No. 01024



**Octagonal Handle #9**  
No. 01109

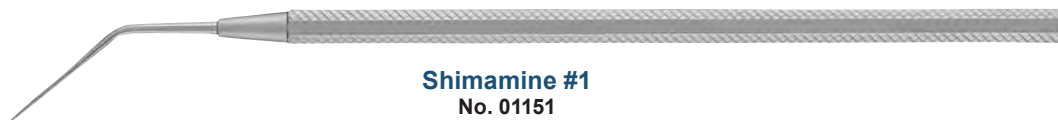

**Shimamine #1**  
No. 01151

**-Ball Point-**



**#1**  
No. 01221



\*The round tip realizes checking of caries without damaging pit and fissure tissues.  
\*Suitable for filling of sealant.

**-Double End-**



**#5**  
No. 01205



**#6**  
No. 01206

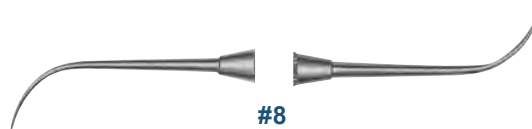

**#8**  
No. 01208

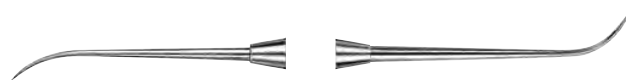

**#3-9**  
No. 01209



**#11-12**  
No. 09224



\*Explorer with the shank of "Gracey Curette #11-12".  
\*Thinness and elasticity at the tip are effective in the check of dental tartar, cavity and surplus cement.

**- for Root Canal Therapy -**



**#16**  
No. 01316





## Explorer Tip (Replaceable Type)

\*Remove all joint parts and replaceable tip before sterilization and disinfection.  
 \*For more replaceable type products see P. 201.



### -Handle-

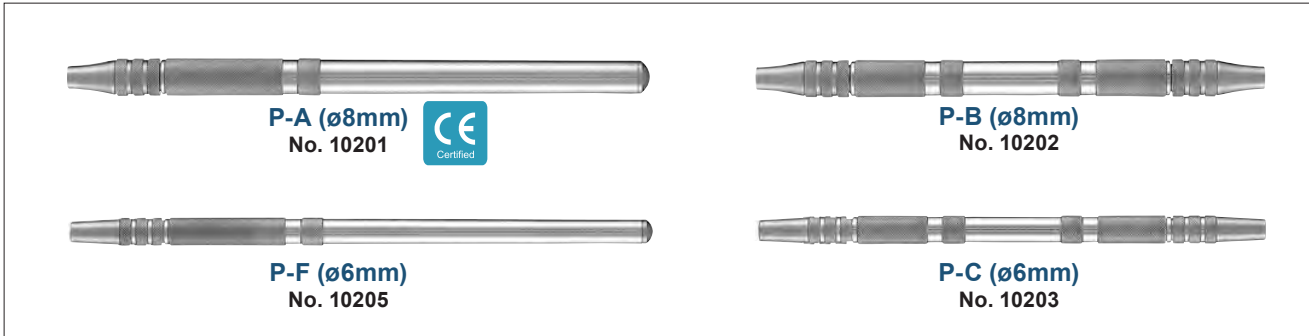

### -Tip (3 ea.)-

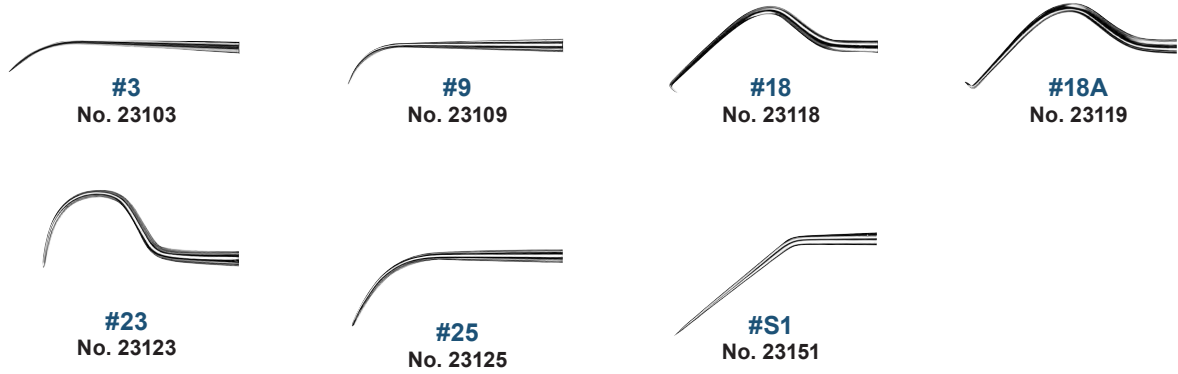

# Excavator



## -Octagonal-



#1  
No. 01501



#2  
No. 01502



#3  
No. 01503



#4  
No. 01504



#5  
No. 01505



#6  
No. 01506

---

## -Round-



#1	#2	#3	#4	#5	#6
01511	01512	01513	01514	01515	01516





## Dressing Tweezers



Size / 160mm

**NC #18**  
No. 11305



Size / 160mm

**NC #18 with Serration**  
No. 11306



Size / 145mm

**Mini #18**  
No. 11308



Size / 145mm

**Mini #18 with Serration**  
No. 11309



**NC #18 with Diamond**  
No. 11307

Size / 160mm



**Premium**  
No. 11019

\*Delicate tweezers.  
\*Careful finish prevents tip misalignment.

Size / 160mm

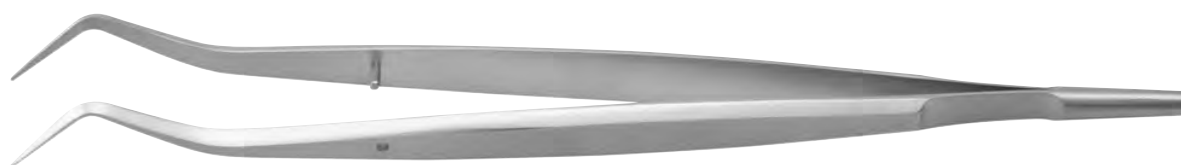

**Koshi**  
No. 11020

Size / 165mm



**Light Weight**  
No. 11024

Size / 165mm





## Mouth Mirror (Simple Stem)

### -Clear 2-

- \*With thin glass, there is little blur of an image and reflected vividly.
- \*Suitable only for YDM mirror handle.

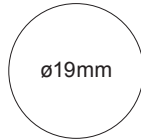

**3P**  
No. 13071  
(20 ea.)

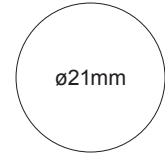

**4P**  
No. 13073  
(20 ea.)

- \*Thickness / 1.9mm
- \*Reflection rate / About 93%

### -Front Surface-

#### \*Titanium Coating

- \*Direct reflection prevents an image blurring.
- \*Suitable only for YDM mirror handle.

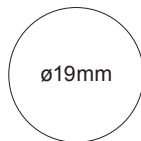
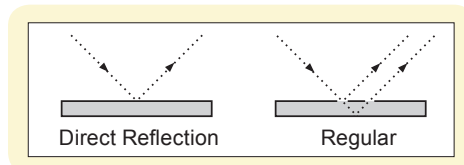

**3P**  
No. 13077  
(12 ea.)

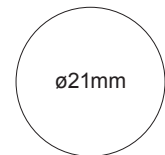

**4P**  
No. 13079  
(12 ea.)

- \*Thickness / 1.9mm
- \*Reflection rate / About 98%

## Metal Mirror (Simple Stem)



- \*The mirror made from stainless steel does not have a fear of being divided, and is suitable for the medical treatment of child dentistry, disabled person dentistry.

- \*Suitable only for YDM mirror handle.

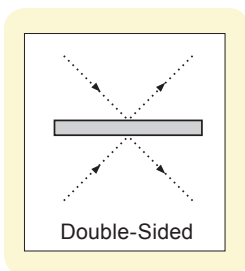

No. 13131  
(6 ea.)

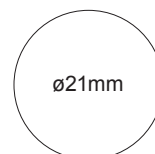

- \*Thickness / 1.1mm
- \*Reflection rate / About 65%



# Mirror Handle



\*Suitable only for YDM mouth mirror.



**Octagonal**  
No. 13121



**SC**  
No. 13127



**YS**  
No. 13128



**Titanium**  
No. 13130





## Disposable Instrument



**Mouth Mirror**  
No. 28102  
(50 ea.)



**Explorer**  
No. 28101  
(50 ea.)



**Periodontal Probe**  
No. 28107  
(50 ea.)

\*Disposable type (Not sterilized)

\*Material / PS : Heatproof temperature 70°C (Handle)

\*Need disinfection by solution or EOG sterilization before use.



## Temporary Filling Carrier

No. 13200



\*A tip is heated and used.

\*To prevent the burn of membrane, a black cover is made to slide to a tip.



## Temporary Filling Remover



**#10**  
No. 03010

# Evacuation Tip



## -Universal-

\*There is no trap for suction prevention attached at the evacuation tip, so it is easy to clean. (Rubber sleeve has a trap)

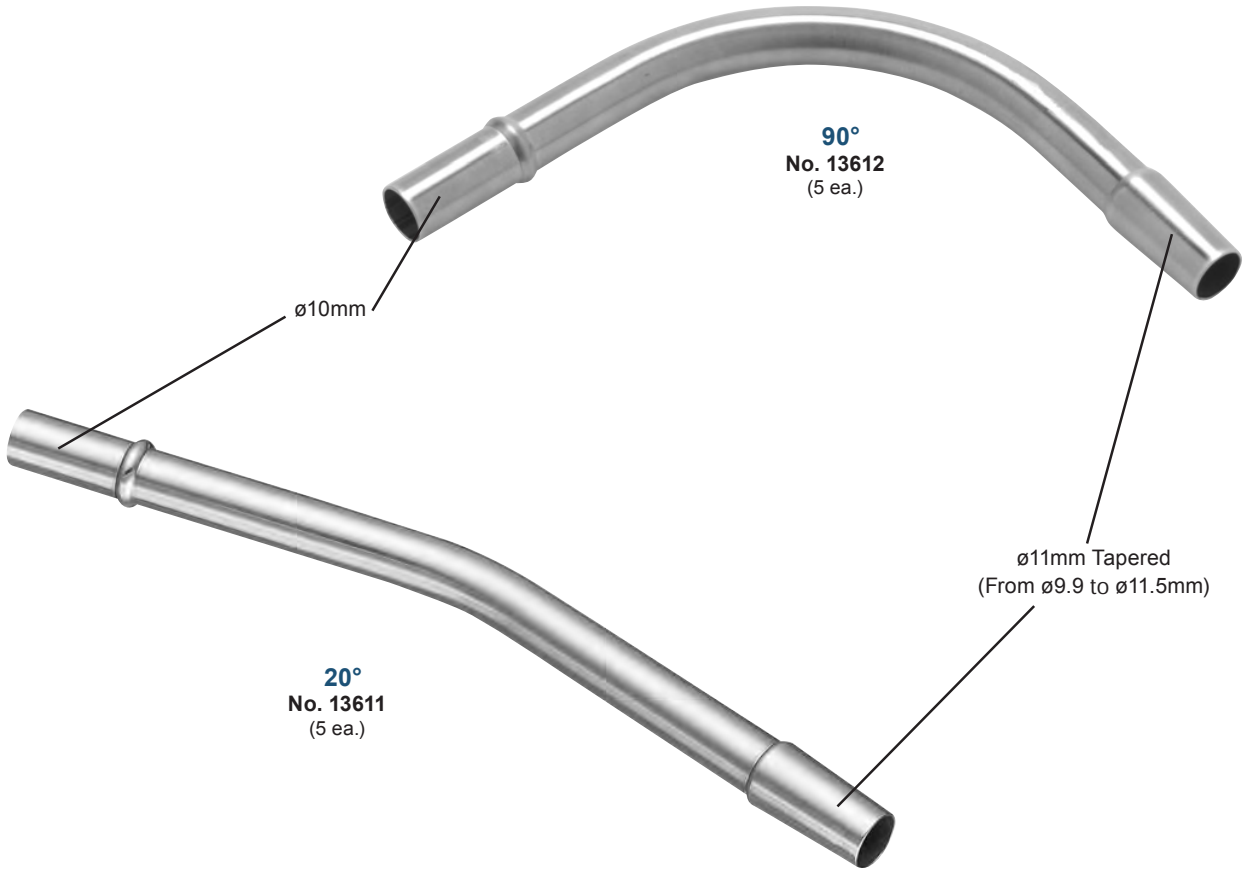

### Sold Separately

#### Rubber Sleeve

No. 13613  
(5 ea.)



\*\*"Rubber Sleeve" has a trap inside.

\*Size / 40mm  
\*Material / Si

#### Adapter

No. 13614



\*Material / PTFE

\*In case the inside diameter of evacuation tube is 16mm, this adaptor is needed for the use of "Evacuation Tip Universal".

#### Cleaning Brush L (ø12mm)

No. 13653  
(12 ea.)



Size / 180mm



## Stainless Dish



\*Excellent when using small portion of bath such as topical anesthesia, local disinfection, etching solution, and temporary filling material (powder or liquid).

No. 13670  
(5 ea.)



\*Hole diameter /  $\phi$ 16mm  
\*Size / W56 x D31 x H8.5mm

## Stainless Tray



**M**  
No. 13413



Size / W245 x D146 x H8mm

**S**  
No. 13410



Size / W245 x D73 x H8mm

